

CRYSTAL STUD PLRE2

DATASHEET

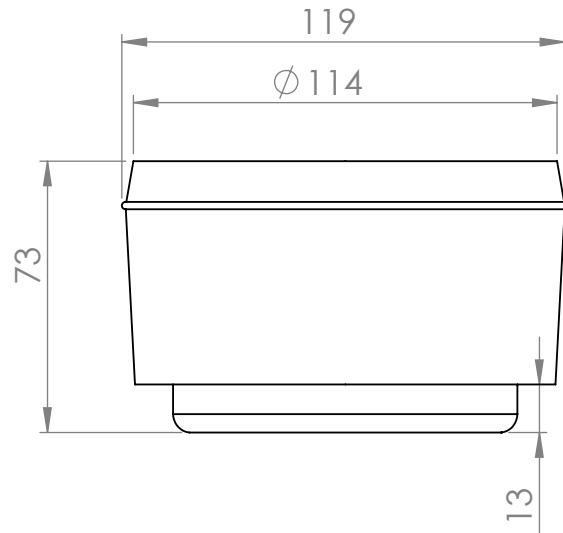

PRODUCT SPECIFICATION

- . Solar outdoor marking fixture with Led Amber, White 3000K, or White 4000 K.
- . Tempered glass frame thickness 15 mm + aluminum tube.
- . Battery LiFePO4 4,5 Ah.
- . Solar panel Sunpower Back Contact with MPPT.
- . Algorithmic management by microprocessor with a guarantee of a load management and computation of an optimal power all year-round considering latitude, season and weather conditions.

-
- . Charging temperatures:- 10°C / + 60°C.
 - . Battery's operating temperature:- 30°C / + 85°C.
 - . Maximum resistance to compression: 3 tons (suitable for the passage of vehicles up to 32 tons).
 - . Weight: 1,25 kg.
 - . Dimensions: 119 x 72 mm.
 - . Class III- IP67- IK10- CE.

-
- . Bluetooth connection to remotely control the product via the Nowatt application:
 - ON/OFF function of the device.
 - Setting of the lighting scenario.
 - Grouping: creation of groups for simultaneous control of the Crystal studs.

LEDS

Choice of Led:

- Amber
- White 3000 K
- White 4000 K

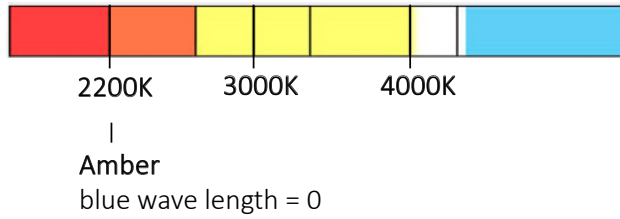

BATTERY

Battery LiFePO4 4,5 Ah		
Cycles	DOD (in %)	Lifespan (in years)
2000	100	5
3000	80	8
8000	55	22

SCENARIOS

The application enables to define the operating time.

NOWATT application available on:

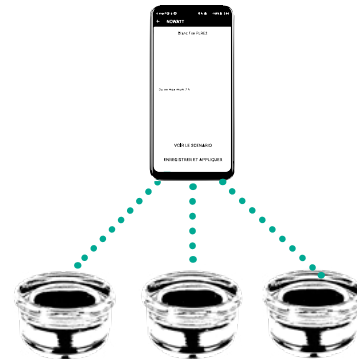
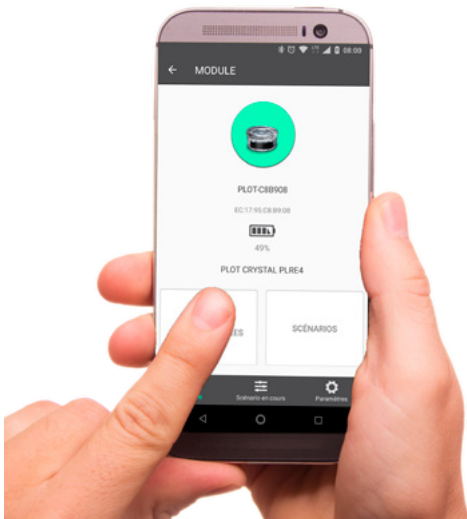

Grouping: possibility to create groups of Crystal Studs PLRE2 on the application and to control them simultaneously.

WARRANTY

Product guaranteed for two years in accordance with the warranties of the French lighting union.

INSTALLATION

The methodology for installing Crystal Studs depends on the type of soil. Please refer to our manual available on request.

EXAMPLE OF INSTALLATION IN UNREINFORCED POURED CONCRETE

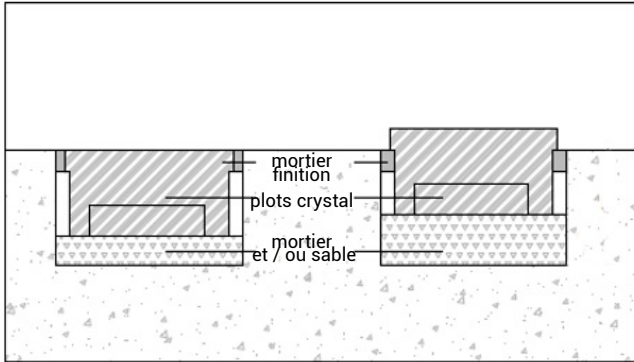

STEP 1

- . Make a core hole of 130 mm in diameter for a minimum depth of 95 mm in the concrete.
- . Remove the core
- . Remove all dust and traces of moisture that would reduce the effectiveness of the mortar.

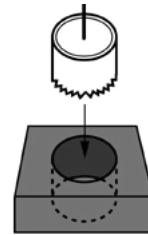

STEP 2

- . Pour a resting mortar or fill with sand according to the following two configurations:

Flush stud:

$$H \text{ (mortar height)} = D \text{ (coring depth)} - 75 \text{ mm}$$

Stud protruding from the height of the collar:

$$H \text{ (mortar height)} = D \text{ (coring depth)} - 60 \text{ mm}$$

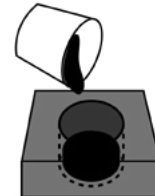

STEP 3

- . Install the stud in the cavity, possibly putting shims to adjust the horizontality.
- . Fill the vertical cavity up to 2 cm before the finished floor. Pack well.
- . Once the mortar is dry, clean the cavity and the stud.

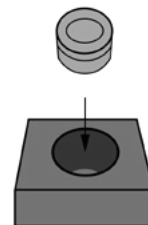

STEP 4

- . Make finishing mortar (rather liquid, match the sand to the colour of the ground).
- . Clean and let the gasket dry 24 hours.

